



CNC PRESS BRAKE

**AKOBEND A-SERIES
AKOBEND B-SERIES**



HYDRAULIC GUILLOTINE SHEAR

**AKOCUT B-SERIES
AKOCUT C-SERIES**



GUILLOTINE SHEAR WITH REDUCER

AKOCUT A-SERIES



HYDRAULIC IRON WORKERS

DOUBLE - SINGLE CYLINDER SERIES

A KOMAC



AKOMAC as the Manufacturer of Sheet Metal Working Machinery, has been a leading provider for the automotive and metal Industry. AKOMAC offers a wide range of products designed to meet all demands. Since 2000, AKOMAC has been committed to serving for customers satisfaction and continuous development.

Quality oriented production and good Customer support have always been the basic rule of the company. Machines are designed to be reliable, durable and precise.

The AKOMAC brand have proven it's futuristic vision by it's development as a manufacturer. The headquarters of the company are fortunate idealist and dynamic. The experienced foreign trade intelligence grants more confidence to the customers.

We determine our mission with the sentence "We giving shape to the Sheet ". We perfectly understand the expectations and requirements of users from our product and provide them to get more performance from the machine. This policy shows our high knowledge and importance we serve to customers' satisfaction.

WHO DO WE WORK WITH

The AKOMAC exports high quality machines to many countries with On 5 continents and with 32 AKOMAC seller;

- In Europe side :** Germany, Denmark, France, Spain, Greece, Romania, Portugal, Poland, Hungary, Bosnia and Herzegovina, Lithuania, England, Serbia, Italy, Russia and Ukraine
- In Middle East side :** Syria, Jordan, Saudi Arabia, Iraq, UAE, Madagascar, Lebanon, Kuwait, Qatar and Iran
- In North America Side:** United States, Canada, Mexico, Colombia
- In South America Side :** Brazil, Uruguay, Chile, Paraguay
- Far East Side :** Vietnam, Singapore, Malaysia, China, South Korea
- In North Africa:** Egypt, Libya, Algeria, Ethiopia, Sudan, Tunisia
- Australia**

As in the past, the future of us contains more opportunities and developments for you to consider the special advantages we offer: High quality with competitive prices. Equipment attached are world known brands like Bosch, Rexroth, Horbiger, Cybelec, Delem, Elgo, Telemecanique, Siemens, Heidenhein, Givi Misure Wila, Wilson, Unimec, Roller, Esa Kvara.

As a sign of the success in manufacturing, our back-up service is ready to work for stabilization in your business. We offer you the best technical support.

STANDARD EQUIPMENT AND FEATURES

- Y1,Y2,X 3 Axes CNC
- Cybelec Touch8 Touch Screen Colour Control Unit
- Akomac X Axis Back Gauge with Servo Motor , Including 2 pcs Finger Blocks
- Manual Crowning
- Support arm with scale & T-Slot & Tilting stop. 2 pcs
- Akomac European Type Top Tool Quick Clamping
- European Type Top Tool H:66,6mm 85° R:08mm
- European Type Bottom Tool 4V H:60x60mm
- Back safety Light Curtains
- Lighting Lamp
- Foot Pedal with Emergency Stop Button

OPTIONAL EQUIPMENT

- Akomac CNC Crowning
- Akomac Heavy Duty X,R Axes Back Gauge with Mitsubishi Servo Motor
- Akomac Heavy Duty X,R,Z1,Z2 Axes Back Gauge with Mitsubishi Servo Motor
- Akomac Heavy Duty X,R,Z1,Z2,X5,X6 Axes Back Gauge with Mitsubishi Servo Motor
- Akomac ATF Type X1,X2,R1,R2,Z1,Z2 Axes Back Gauge with Mitsubishi Servo Motor
- Sliding Rear Door
- Custom Full-length casing
- Stand Type Foot Pedal with Emergency Stop Button (Fiessler Brand)
- Sheet Follower, Mitsubishi Servo Motor
- Oil Heater
- Oil Coolant with Fan
- Roller European Type Hydraulic Top Tool Clamping
- Roller European Type Hydraulic Bottom Tool Clamping
- Central Lubrication Manual
- Central Lubrication Motorized
- CE with Manual Fiessler AKAS II M-FMSC (Safety Plc)



GENERAL FEATURES

- The machine frame manufactured with the advanced technology with exact tolerances and stress relieved with significant welded components.
- All tensile points designed with large radii and strain accumulation and possible welding cracks eliminated.
- The lower and upper tables' inertias designed for optimum value for minimum deformation.
- The top plate intended to positioned vertically so that the roller bearings, piston bearings, and felts can compensate for vertical loads.
- The hydraulic cylinder is designed as double-sided and honed to surface quality of 2 microns. Thus, minimum wear resistance is created for the felts. The cylinder bodies manufactured as SAE 1040 material forged.
- The hydraulic cylinders are bolted to the front of the feet with bolts and cams to provide excellent leveling and load balancing.
- Piston head features: Omega-type felts fitted with full bronze bearings, semi-angled sleeves.
- The pistons are precision ground and hard chrome plated to provide low friction and abrasion resistance when the piston passes through the felts.

- The adjustable top tray slides made from materials that are suitable for little friction resistance. These beds arranged for guiding to move the top table from right to left and front to rear.
- The Akomac hydraulic system allows precise usage at all pressure values up to the maximum operating pressure. At the same time, with these pressure values, precise cylinder positioning, synchronization, and repeatability are achieved.
- Backgauge system manufactured following environmental conditions. Backgauge bearings made for heavy conditions with double bearers. Scrapping type bearings used against dust and other particles that will accumulate in the linear guideways against dusty environmental conditions.
- The outer surface of the machine is painted with two layers of paint at least 60 microns in thickness to protect against weather conditions. Paint drying is done gradually in a different time and temperature ranges in state-of-the-art ovens.
- Standard Y1, Y2, X-axis.



Machine Type	Bending force Ton	Bending length		Stroke mm	Daylight mm	Throat depth mm	Table height mm	Pit Depth mm	Table width mm	Support Arm Pcs	Y Rapid speed mm/sn.	Y Axis Bend Speed mm/sn.	Y Return speed mm/sn.	X Axis Speed mm/sn.	R Axis Speed mm/sn.	Travel in R-axis mm
		A	B													
		C	D													
1560	60	1500	1300	265	485	410	850	--	108	2	150	9	110	350	40	200
2080	80	2100	1700	265	485	410	850	--	108	2	145	9	115	350	40	200
26100	100	2600	2200	265	485	410	900	--	108	2	130	10	110	350	40	200
3100	100	3100	2600	265	485	410	900	--	108	2	130	10	110	350	40	200
3135	135	3100	2600	265	485	410	900	--	108	2	120	9	95	350	40	200
3175	175	3100	2600	265	485	410	900	--	108	2	120	10	120	350	40	200
3220	220	3100	2600	265	485	410	900	--	108	2	140	10	110	350	40	200
3270	270	3100	2600	265	485	410	900	--	108	2	125	9	95	350	40	200
3320	320	3100	2600	365	585	510	900	--	154	2	110	7	95	350	40	200
3400	400	3100	2400	365	605	510	950	--	154	2	80	8,5	85	350	40	200
37175	175	3700	3200	265	485	410	900	--	108	2	120	10	120	350	40	200
37220	220	3700	3200	265	485	410	950	--	108	2	140	10	110	350	40	200
37320	320	3700	3200	365	585	510	950	--	154	2	110	9	90	350	40	200
4175	175	4100	3600	265	485	410	900	--	108	2	120	10	120	350	40	200
4220	220	4100	3600	265	485	410	950	--	108	2	140	9	110	350	40	200
4270	270	4100	3600	265	485	410	950	--	108	2	125	9	95	350	40	200
4320	320	4100	3600	365	585	510	1000	--	154	2	90	7	95	350	40	200
4400	400	4100	3400	365	605	510	1050	--	154	2	80	8	85	350	40	200
4500	500	4100	3200	365	605	510	1060	--	154	2	70	7	75	350	40	200
4600	600	4100	3200	365	605	510	1120	--	154	2	90	7	85	350	40	200
5220	220	5100	4200	265	485	410	1050	--	108	3	140	10	80	250	40	200
5270	270	5100	4200	265	485	410	1070	--	108	3	125	9	80	250	40	200
5320	320	5100	4200	365	585	510	1070	--	154	3	90	9	80	250	40	200
5400	400	5100	4100	365	605	510	1150	--	154	3	80	8,5	65	250	40	200
5500	500	5100	4100	365	605	510	950	1000	154	3	70	7	75	250	40	200
5600	600	5100	4100	365	605	510	950	1250	154	3	70	7	70	250	40	200
6220	220	6100	5100	265	485	410	1150	--	154	3	110	8	80	250	40	200
6320	320	6100	5100	365	585	510	1150	--	154	3	90	8	80	250	40	200
6400	400	6100	5100	365	605	510	1200	--	154	3	80	8,5	65	250	40	200
6500	500	6100	5100	365	605	510	950	1250	154	3	75	7	75	250	40	200
6600	600	6100	5100	365	605	510	950	1400	154	3	70	7	70	250	40	200

Akomac has right to change catalogue values and machine technical details without notice. Misprints are not restrictive.

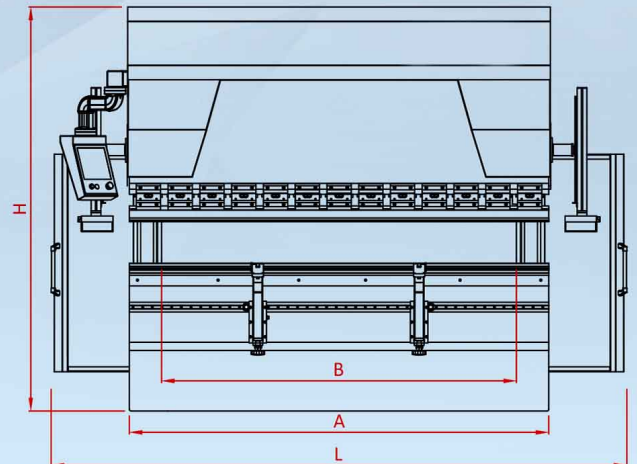

Machine Type	Travel in X-axis			Motor power	Oil Capacity	Length	Width	Height	Approximate Weight
	500	700	1000						
	mm S	mm Op.	mm Op.						
1560	S	--	Op.	7,5	100	2400	1750	2550	4300
2080	S	--	Op.	7,5	100	3050	1830	2680	5700
26100	S	--	Op.	11	100	3450	1900	2710	6700
3100	--	S	Op.	11	100	3950	1900	2760	8000
3135	--	S	Op.	15	250	3950	1950	2810	9000
3175	--	S	Op.	18,5	250	3950	1980	2850	11000
3220	--	S	Op.	22	250	4000	2000	2920	12200
3270	--	S	Op.	22	350	4000	2000	2950	13000
3320	--	S	Op.	30	350	4050	2100	3060	16000
3400	--	S	Op.	37	350	4050	2250	3300	18700
37175	--	S	Op.	18,5	250	4550	2000	2900	11500
37220	--	S	Op.	22	250	4550	2000	3000	13900
37320	--	S	Op.	30	350	4600	2250	3250	18000
4175	--	S	Op.	18,5	250	4950	2000	2950	13000
4220	--	S	Op.	22	250	4950	2000	3000	15000
4270	--	S	Op.	22	350	4950	2000	3000	17500
4320	--	S	Op.	30	350	5000	2250	3250	20500
4400	--	S	Op.	37	350	5000	2250	3450	24700
4500	--	S	Op.	45	400	5050	2290	3520	27000
4600	--	S	Op.	45	500	5050	2290	3650	31200
5220	--	S	Op.	22	350	6000	2000	3260	18000
5270	--	S	Op.	22	350	6000	2000	3310	19800
5320	--	S	Op.	30	350	6050	2100	3380	22600
5400	--	S	Op.	37	400	6050	2280	3620	28500
5500	--	S	Op.	45	500	6050	2320	3720	34000
5600	--	S	Op.	45	500	6050	2580	3800	41000
6220	--	S	Op.	22	350	7000	2000	3350	22000
6320	--	S	Op.	30	350	7000	2250	3550	28000
6400	--	S	Op.	37	500	7050	2250	3710	35000
6500	--	S	Op.	45	500	7200	2580	3830	41800
6600	--	S	Op.	45	500	7200	2650	3900	50500

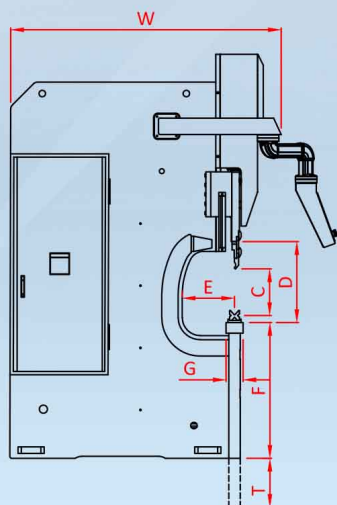

The most crucial factor for precision bending in press brakes is the Backgauge system.

Akomac design features a unique, powerful and precise back gauge system that works on linear guideways at side counters and large-sized ball screws. The special design has robust construction due to its strong mechanical structure and can withstand large loads.

The back gauge finger blocks move on top of the double-rail and aluminum-plated top profile. These back gauge finger blocks are very sensitive and can be adjusted from any point.



Backgauge Finger



X BACKGAUGE

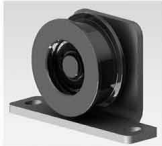

H: Belt tensioning mechanisms used to prevent the trigger belts, which engage the X axis motor, from making a gap.

D: High resolution MITSUBISHI servo motor in the precision positioning axis.

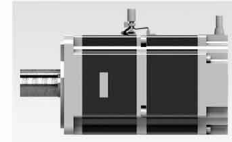

F: Resistant to wear and deformation, precisely adjustable, and heat treated backgauge finger blocks.



C: The X Axis console is manufactured with impact-resistant system.

F: Mechanical braking system to prevent movement of fingers due to shocks and vibrations during operation.

G: Thanks to the tapered bearing made of tapered roller at the ends of the ballscrews, the cavities which could be formed in the ballscrew position are removed.

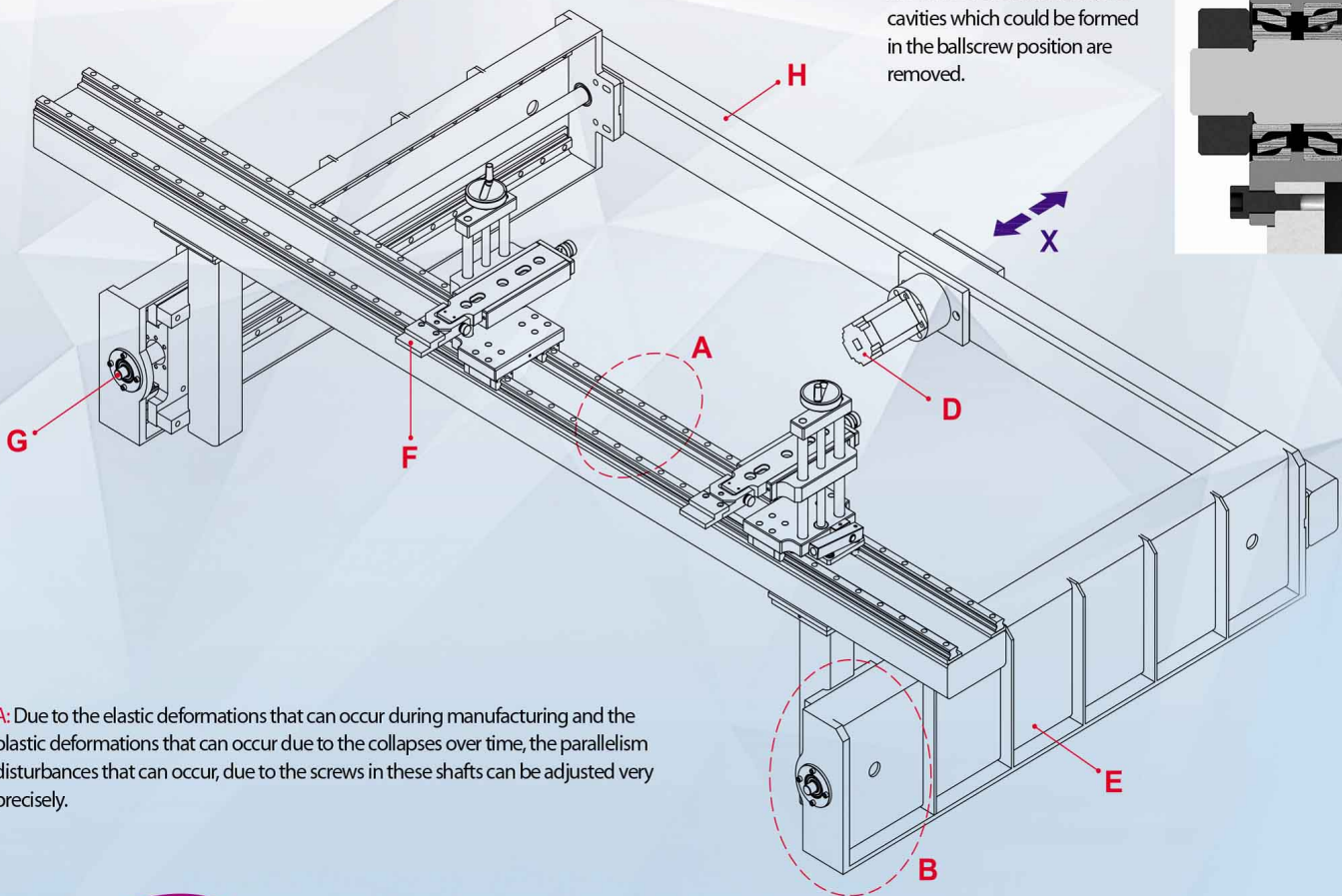
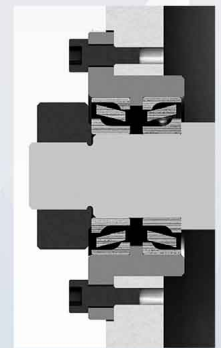

A: Due to the elastic deformations that can occur during manufacturing and the plastic deformations that can occur due to the collapses over time, the parallelism disturbances that can occur, due to the screws in these shafts can be adjusted very precisely.

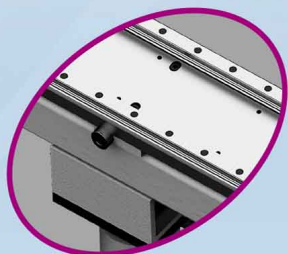

A: Movable top profile designed to absorb deformations that may occur in the trapezoid and precisely calibrate the distance to the bottom tool.

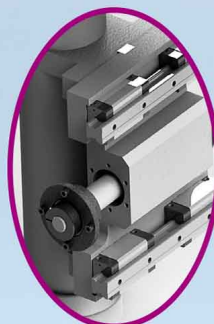

B: 4 pcs square type double row linear guideways and ballscrew are used so that our consoles do not cause any gap due to the collapses.

E: Strengthened steel construction and vibration-proof and durable side console.

The most crucial factor for precision bending in press brakes is the Backgauge system.

Akomac design features a unique, powerful and precise back gauge system that works on linear guideways at side counters and large-sized ball screws. The special design has robust construction due to its strong mechanical structure and can withstand large loads.

The back gauge finger blocks move on top of the double-rail and aluminum-plated top profile. These back gauge finger blocks are very sensitive and can be adjusted from any point.

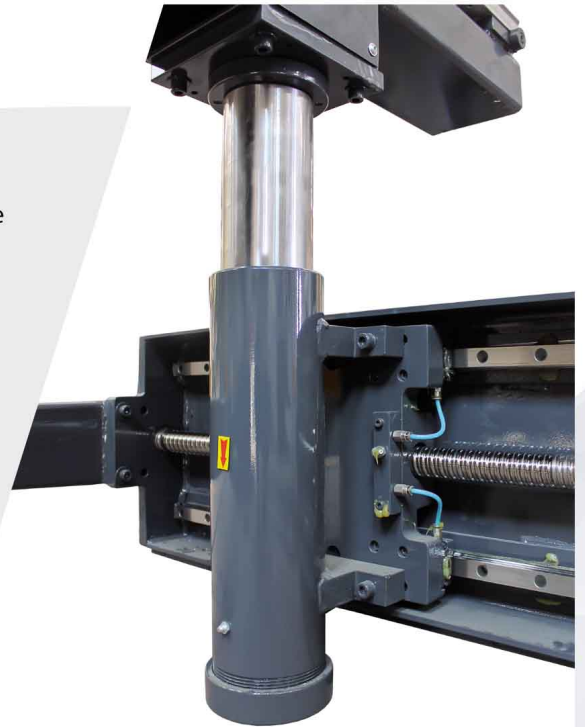

Backgauge Finger



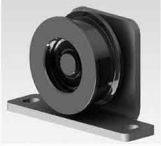

H: Belt tensioning mechanisms used to prevent the trigger belts, which engage the X axis motor, from making a gap.

D: High resolution MITSUBISHI servo motor in the precision positioning axis.

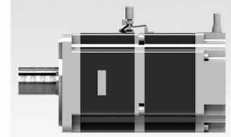

C: The R Axis console is manufactured with a ball screw which is movable with a 200 mm stroke, with impact-resistant and anti-backlash system.

F: Resistant to wear and deformation, precisely adjustable, and heat treated backgauge finger blocks.

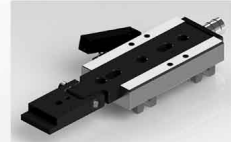

F: Mechanical braking system to prevent movement of fingers due to shocks and vibrations during operation.

G: Thanks to the tapered bearing made of tapered roller at the ends of the ballscrews, the cavities which could be formed in the ballscrew position are removed.

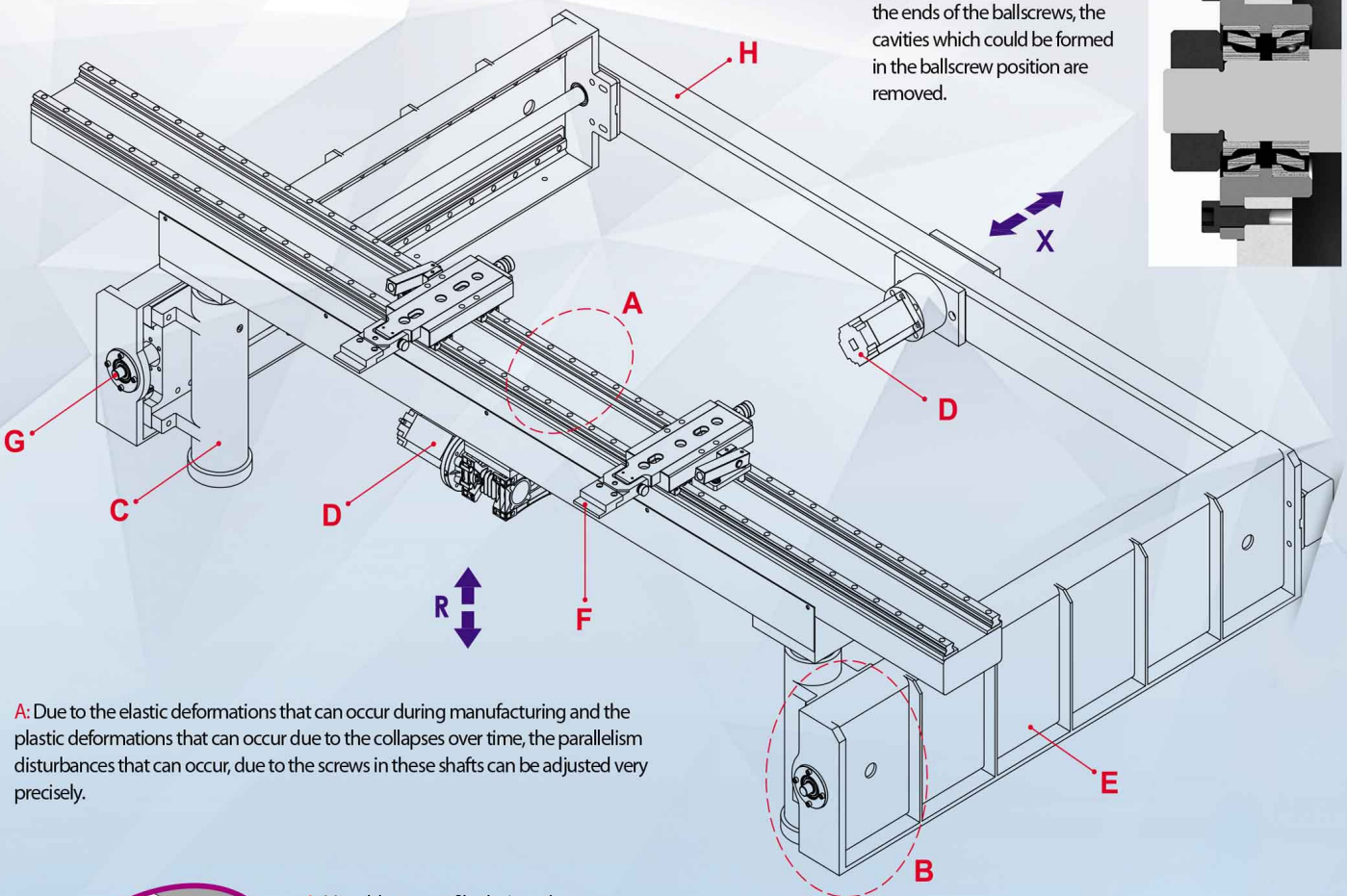
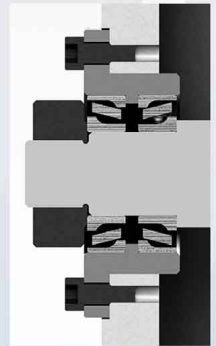

A: Due to the elastic deformations that can occur during manufacturing and the plastic deformations that can occur due to the collapses over time, the parallelism disturbances that can occur, due to the screws in these shafts can be adjusted very precisely.

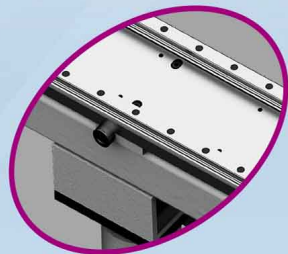

A: Movable top profile designed to absorb deformations that may occur in the trapezoid and precisely calibrate the distance to the bottom tool.

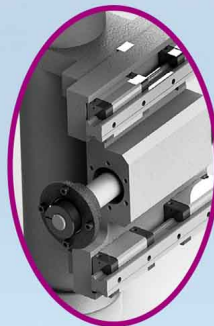

B: 4 pcs square type double row linear guideways and ballscrew are used so that our consoles do not cause any gap due to the collapses.

E: Strengthened steel construction and vibration-proof and durable side console.

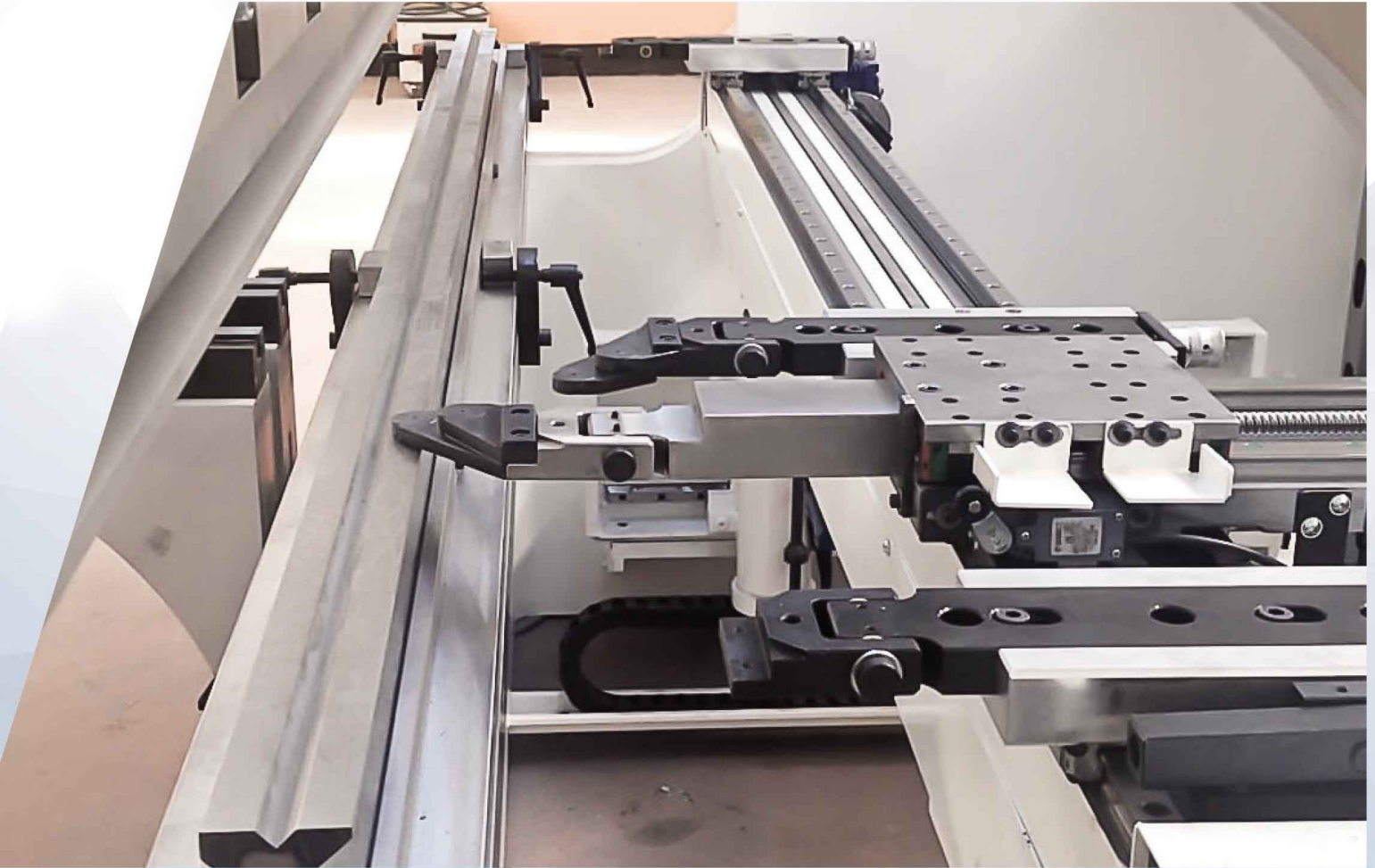

The most crucial factor for precision bending in press brakes is the Backgauge system.

Akomac design features a unique, powerful and precise back gauge system that works on linear guideways at side counters and large-sized ball screws. The special design has robust construction due to its strong mechanical structure and can withstand large loads.

The back gauge finger blocks move on top of the double-rail and aluminum-plated top profile. These back gauge finger blocks are very sensitive and can be adjusted from any point.

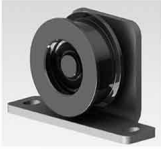

H: Belt tensioning mechanisms used to prevent the trigger belts, which engage the X axis motor, from making a gap.

D: High resolution MITSUBISHI servo motor in the precision positioning axis.

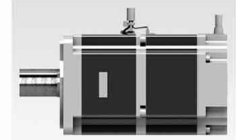

C: The R Axis console is manufactured with a ball screw which is movable with a 200 mm stroke, with impact-resistant and anti-backlash system.

F: Resistant to wear and deformation, precisely adjustable, and heat treated backgauge finger blocks.

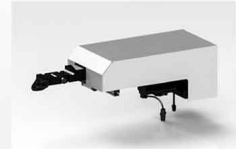

F: Mechanical braking system to prevent movement of fingers due to shocks and vibrations during operation.

G: Thanks to the tapered bearing made of tapered roller at the ends of the ballscrews, the cavities which could be formed in the ballscrew position are removed.

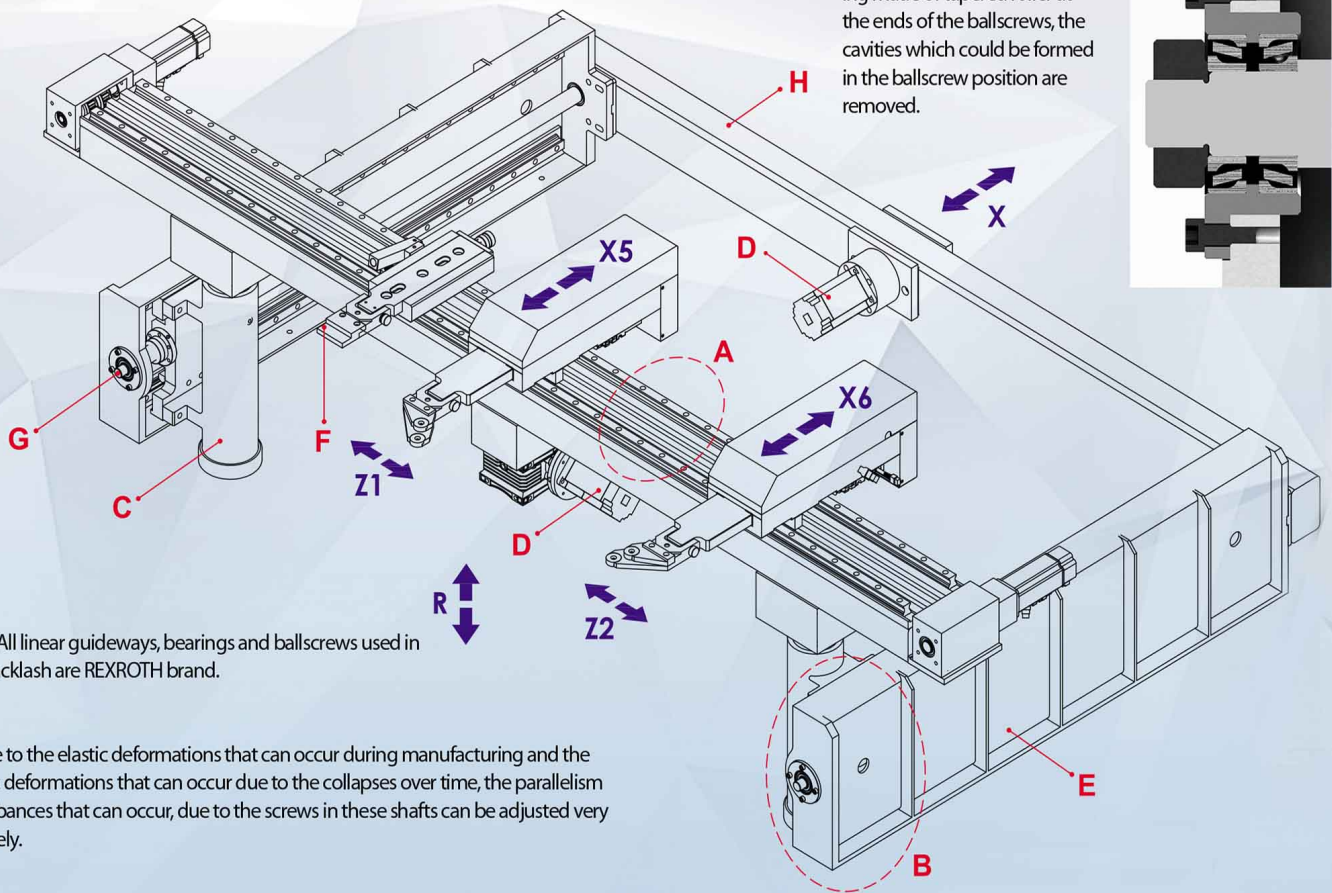
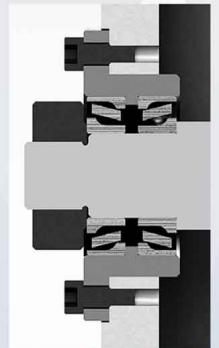

Note: All linear guideways, bearings and ballscrews used in our backlash are REXROTH brand.

A: Due to the elastic deformations that can occur during manufacturing and the plastic deformations that can occur due to the collapses over time, the parallelism disturbances that can occur, due to the screws in these shafts can be adjusted very precisely.



A: Movable top profile designed to absorb deformations that may occur in the trapezoid and precisely calibrate the distance to the bottom tool.

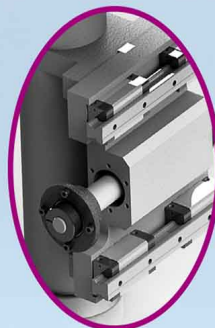

B: 4 pcs square type double row linear guideways and ballscrew are used so that our consoles do not cause any gap due to the collapses.

E: Strengthened steel construction and vibration-proof and durable side console.

X-R-Z1-Z2 BACKGAUGE



ATFX1-X2-R1-R2-Z1-Z2 BACKGAUGE

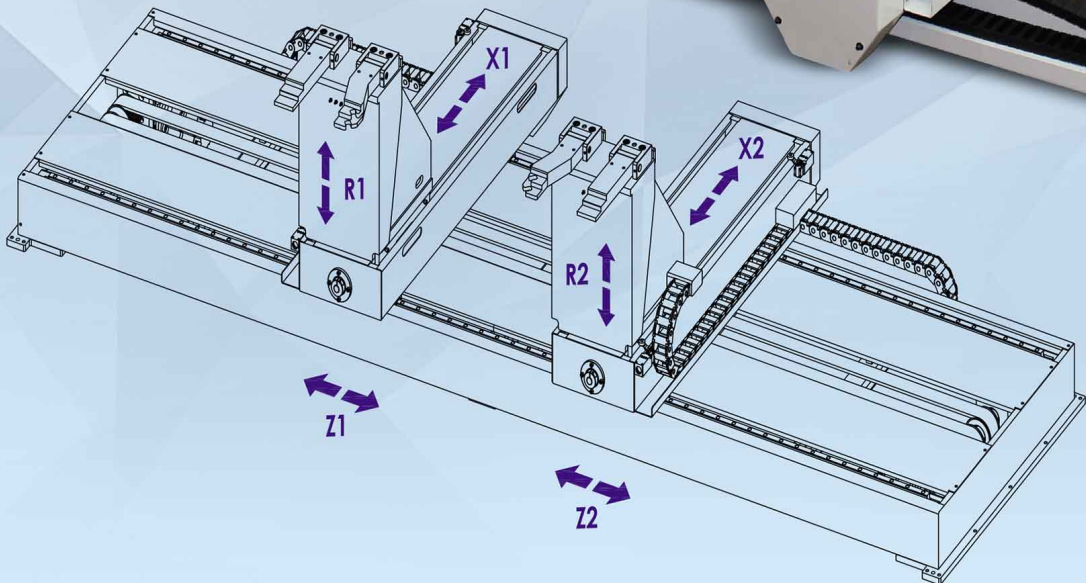

HYDRAULIC SYSTEM

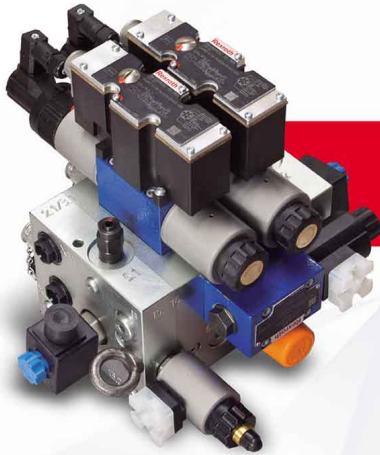

REXROTH
Hydraulic
Block

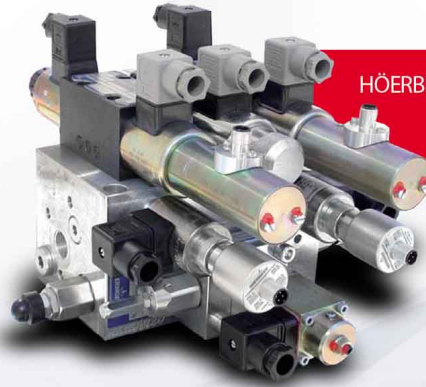

HÖERBIGER-HAWE
Hydraulic
Block



Modular
Hydraulic
Tank

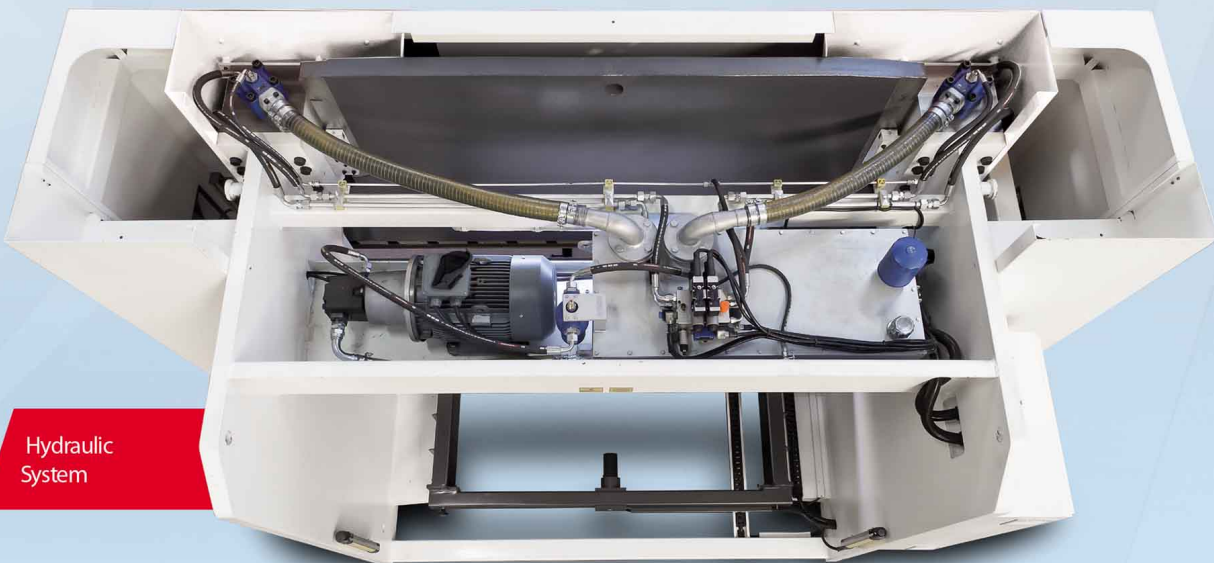

Hydraulic
System

Hydraulic Block type may vary depending on the machine construction.

CONTROL UNITS

CYBELEC TOUCH8 2D



- 8" Colored Touch Screen.
- 2D graphic profile creation with manual sequencing (option).
- Bending sequences and programs can be memorized.
- Easy single bends with the EasyBend page.
- USB Flash Memory port for data transfer/backup
- User Language Options
- Easy Tool Drawing

CYBELEC TOUCH12 2D



- 12" Colored Touch Screen.
- 2D graphic profile creation with manual sequencing (option).
- Bending sequences and programs can be memorized.
- Easy single bends thanks to the "EasyBend" page.
- USB Flash Memory port for data transfer/backup
- User Language Options
- Easy Tool Drawing

CYBELEC TOUCH15 2D



- 15" modern streamlined glass surface touch screen that can be used with gloves.
- User friendly HMI thanks to intuitive programming and easy to set up with dedicated wizards (autotuning).
- 2D graphical profile drawing (Touch Profile) and precise 2D program creation.
- Automatic bending sequence calculation.
- Easy single bends thanks to the EasyBend page.
- Wide storage capacity.
- Internal backup and restore functions.
- Wireless communication for extended diagnostics and updates (with laptop).

CYBELEC VISITOUCH19 2D



- 19" modern streamlined glass surface touch screen that can be used with gloves.
- User friendly HMI, similar to the CybTouch's one, thanks to an intuitive programming and dedicated set-up wizards (autotuning).
- 2D graphical profile drawing (Touch Profile) and precise 2D program creation.
- Automatic bending sequence calculation.
- Running under Windows 7 for multitasking and networking.
- Internal backup and restore functions.
- Outstanding diagnostic tools

CYBELEC VISITOUCH 19MX 3D

- 19" modern streamlined glass surface touch screen that can be used with gloves.
- User friendly HMI, similar to the CybTouch's one, thanks to an intuitive programming and dedicated set-up wizards (autotuning).
- Full 3D visualisation and simulation.
- Parts management with DXF flat pattern and 3D format files import.
- Automatic solutions of complex parts: automatic bend sequencing, gauging, tooling and auto segmentation.
- Running under Windows 7 for multitasking and networking.
- Internal backup and restore functions.
- Outstanding diagnostic tools.



DELEM DA58T 2D

- 15" Colored Touch Screen.
- 2D graphic profile creation with automatic sequencing.
- Automatic bend sequence calculation and collision detection
Full 3D machine set-up with multiple tool stations
- USB Flash Memory port for data transfer/backup
- User Language Options



DELEM DA66T 2D

- 17" Colored Touch Screen.
- 2D graphic profile creation with automatic sequencing.
- On-screen finger profile drawing. • Touch Screen Scaling • Full 3D Simulation
- 1 GB Hard Disk Drive (HDD) - 256 MB part memory
- Windows Operating System • User Language Options
- Automatic bend sequence calculation and collision detection & Full 3D machine set-up with multiple tool stations • USB Flash Memory port for data transfer/backup
- RJ45 Ethernet for network
- Delivered with offline software (This software allows you to create, calculate, and control the feasibility of parts on a desktop/laptop computer at the office)



DELEM DA69T 3D

- 17" Colored Touch Screen.
- 2D & 3D graphic profile creation with automatic sequencing.
- On-screen finger profile drawing. • Touch Screen Scaling • Full 3D Simulation
- 1 GB Hard Disk Drive (HDD) - 256 MB part memory
- Windows Operating System • User Language Options
- Automatic bend sequence calculation and collision detection & Full 3D machine set-up with multiple tool stations • USB Flash Memory port for data transfer/backup
- RJ45 Ethernet for network
- Delivered with offline software (This software allows you to create, calculate, and control the feasibility of parts on a desktop/laptop computer at the office)



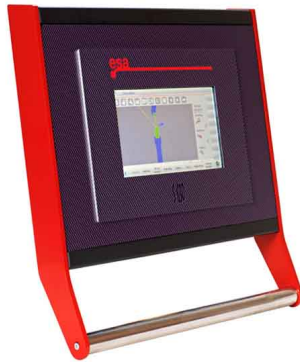

ESA S630 2D

- 10" Touchscreen Color Display.
- Creating 2D Graphics profile with automatic convolution sequence.
- 3D Simulation.
- Part Scratching with touchscreen.
- Bending sequences and programs can be stored in memory.
- Easy single bending page.
- USB memory port for data transfer / backup.
- Windows operating system
- Windows networking with Ethernet connectivity
- User Language option



ESA S640 2D

- 15" Touchscreen Color Display.
- Creating 2D Graphics profile with automatic convolution sequence.
- 3D Simulation.
- Part Scratching with touchscreen.
- Bending sequences and programs can be stored in memory.
- Easy single bending page.
- USB memory port for data transfer / backup.
- Windows operating system
- Windows networking with Ethernet connectivity
- User Language option



ESA S660W 3D

- 19" Touchscreen Color Display.
- Creating 3D Graphics profile with automatic convolution sequence.
- 3D Simulation.
- Part Scratching with touchscreen.
- Bending sequences and programs can be stored in memory.
- Easy single bending page.
- USB memory port for data transfer / backup.
- Windows 7 operating system
- 20 GB HDD
- Windows networking with Ethernet connectivity
- User Language option

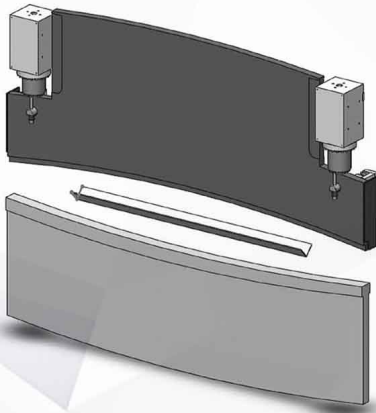

Bending without Crowning

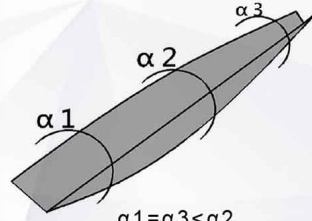

$$\alpha 1 = \alpha 3 < \alpha 2$$

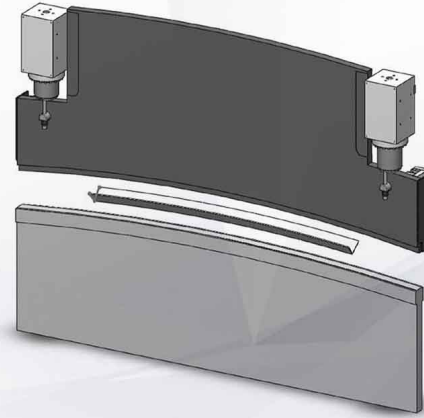

Bending with Crowning

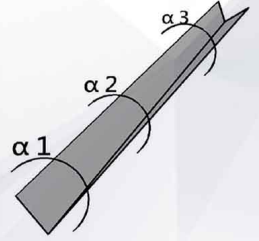

$$\alpha 1 = \alpha 2 = \alpha 3$$

Advantages of crowning to achieve a constant angle;

A press brake's bending precision is affected by the deviations of the upper and lower table as well as other factors.

Press brakes deviate from the opposite direction.

Penetration of the force obtained into the tool is not constant, and the angle is not the same over the length of the machine.

The independent right and left axes (Y1 and Y2) controlled both by proportional valves and linear position control systems.

The crowning system distributes the bending force equally to each point of the bending part to ensure correct bending results.

Manual Crowning



CNC Controlled Motorized Crowning



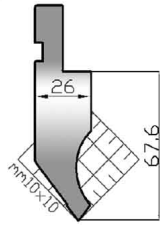

110/75

max 1000 kN/mt

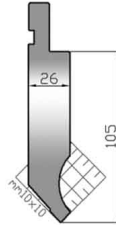

110/75/h105

max 1000 kN/mt

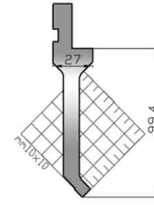

143/88

max 500 kN/mt

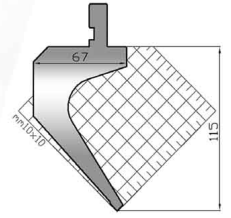

141/85

max 700 kN/mt

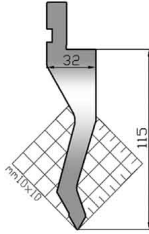

134/60

max 700 kN/mt

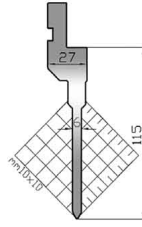

151/60

max 500 kN/mt

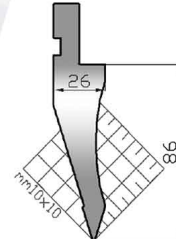

112/35

max 700 kN/mt

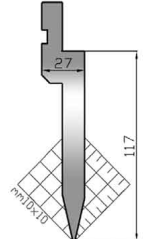

122/26

max 1000 kN/mt

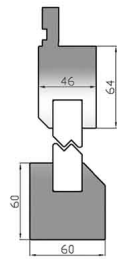

130

max 1000 kN/mt

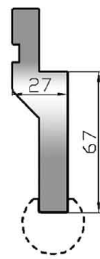

119 h67

max 800 kN/mt

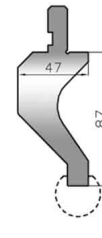

119c h87

max 500 kN/mt

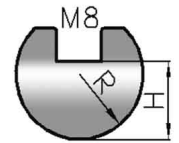

305

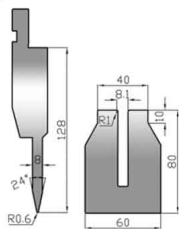

138 l8+m8

max 500 kN/mt

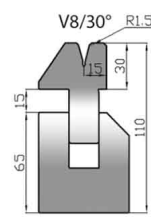

306/30 v8

max 800 kN/mt

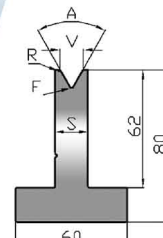

220 h80

max 250-1000 kN/mt

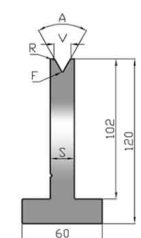

420 h120

max 250-1000 kN/mt

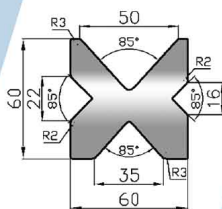

209/v4

max 800 kN/mt

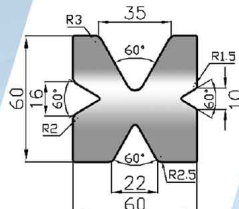

210/v4

max 600 kN/mt

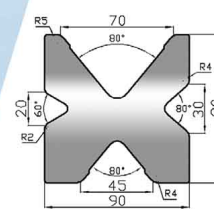

203/v4

max 600 kN/mt

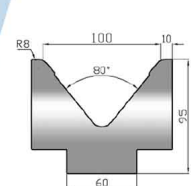

211/100

max 1000 kN/mt

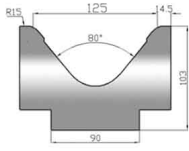

211/125
max 1000 kN/mt

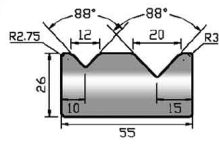

214/88
max 1000 kN/mt

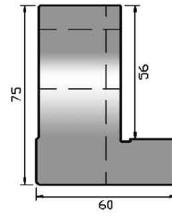

408/75

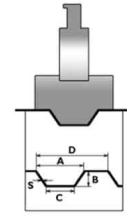

SP14

Bottom Table Types

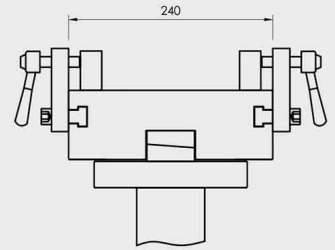
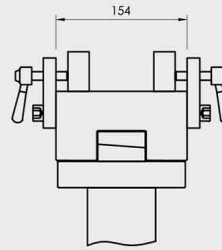
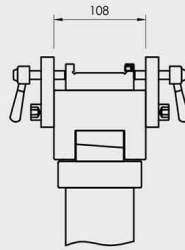

Multi V Bottom Tables

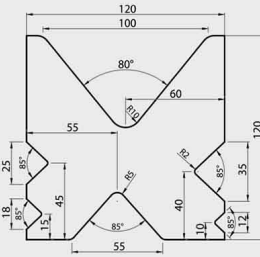
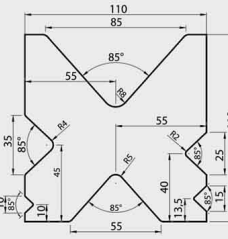
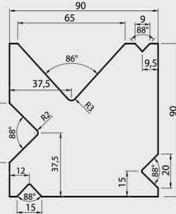

Multi V Bottom Tables

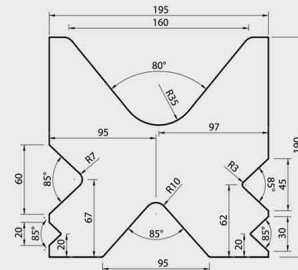
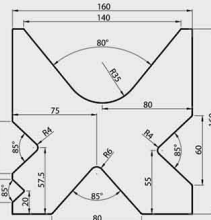
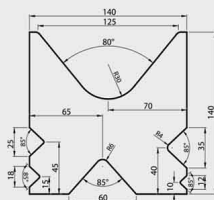

V 60-80-100-120-140-160 / V 60-80-100-120-140-160-180-200 / V 60-80-100-120-140-160-180-200-220-240

Adjustable Bottom Tables

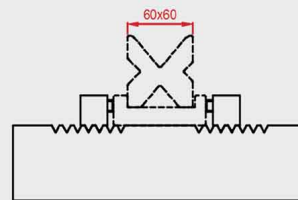
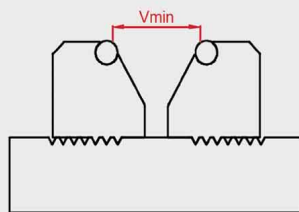
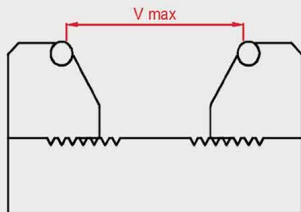



WILA Type
Bottom Tool
Hydraulic
Clamping System

WILA Type
Top Tool
Hydraulic
Clamping System



Rolleri European Type
Hydraulic Top Tool
Clamping



Rolleri European Type
Hydraulic Bottom Tool
Clamping



BENDING POWER TABLE

V	D (Min)	R	S (min)																					
			0,5	0,8	1	1,2	1,5	1,8	2	2,5	3	3,5	4	4,5	5	6	7	8	9	10	12	15	18	20
6	5	1	2,5	6,5	10																			
8	6	1,3	2	5	8	11																		
10	7	1,7	1,5	4	6	9	13																	
12	9	2		3	5	7	11	16																
15	12	2,7			4	6	9	13	16															
20	15	3,3				4	7	10	12	19														
26	18	4,2					5	7,5	9	14	21													
30	22	5						6,5	8	12	19	24												
32	23	5,4							7,5	11,6	17	23	30											
37	25	5,8								10	14,5	20	26	33										
42	29	6,7									13	17	23	29	35,5									
45	32	7,5										16	21	27	33	48								
50	36	8,3											19	24	30	43	58							
60	43	10												20	25	36	49	64						
70	50	11,5													21	31	42	55	69					
80	57	13,5														27	37	48	60	75				
90	64	15															32	42	54	66	95			
100	71	17																38	48	60	86	134		
130	90	22																	37	46	66	103	149	
180	130	30																		33	48	75	107	133
200	145	33																			43	67	97	119
250	180	42																				54	77	95

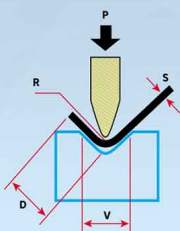

- : Nominal Working Capacity (Ton)
- L : Maximum bending length
Table L = 1000mm
- V : Tool Width (mm)
- D : Minimum sheet bending distance (mm)
- R : Bending Radius
- S : Material Thickness (mm)
- V̄ : Material Tensile Strength (V̄=42 kg/mm²)
- P : Bending Force (Ton)

$$P = \frac{1.42 \times \bar{V} \times S^2 \times L}{1000 \times V} \text{ (Ton)}$$



Sheet Follower

Mitsubishi Servo Motors



Mitsubishi Drivers



The movement of the back-gauge is operated by the CNC control unit in hydraulic press brakes.

The high performance servo motors produced by Mitsubishi move the bearing axes.

Precision parts are produced by these motors. The electrical circuit components used are Siemens, Telemecanique and Schneider brand products.

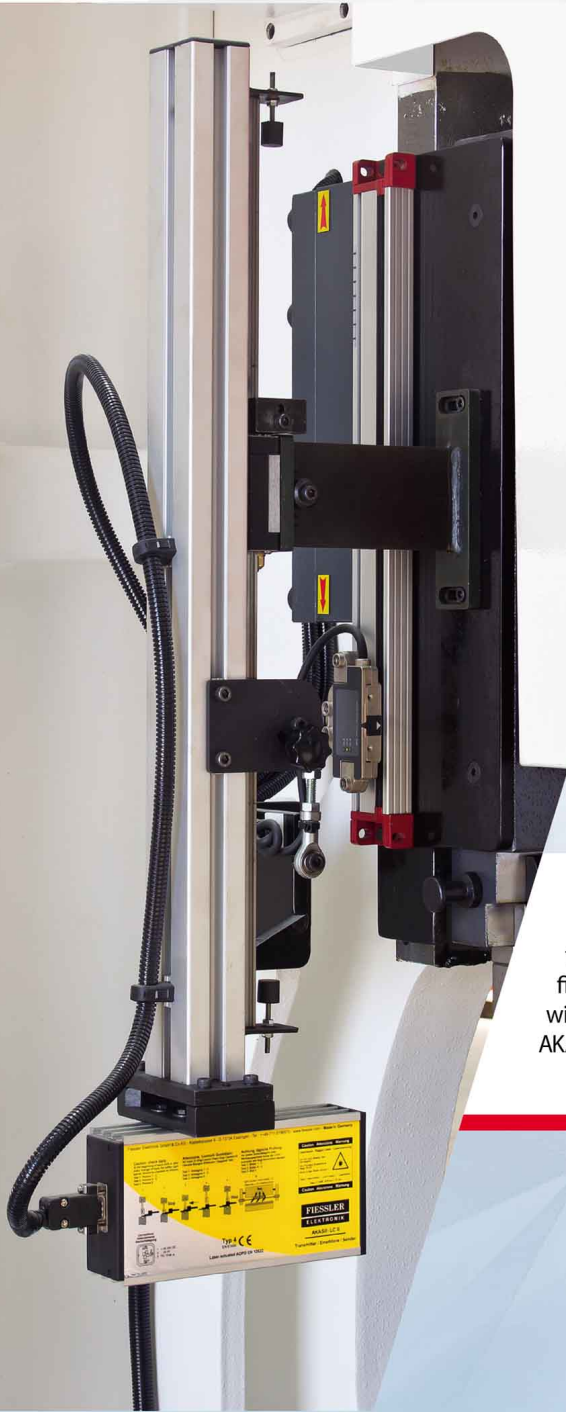

Stand Type
Foot Pedal



Easily adjustable
front Laser
finger protection
with linear guideways
AKAS II M-FMSC



Magnescales



Quick & Easy Adjustable Support Arms.

It is mounted in front of the machine in such a way as to move on a linear slide system and on a ball bearing.

It is easy to use by taking the desired position even when lightly pushed, and it is also possible to adjust it vertically.

European Type
Quick Release System

European Type
Top Tool



Narrow Table



Manual
Central
Lubrication



Oil Cooler
with fan

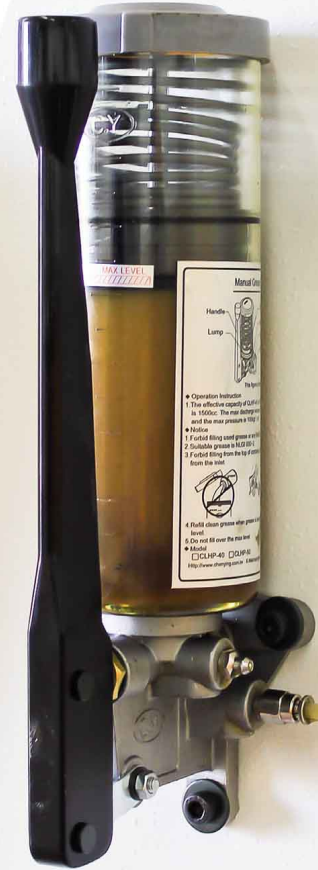

Oil Heaters



Motorized Central Lubrication





The bedding of the top table kept longer to avoid stretch during bending and easy to slip.

To keep the bedding outside of the columns provides an advantage in box bends.

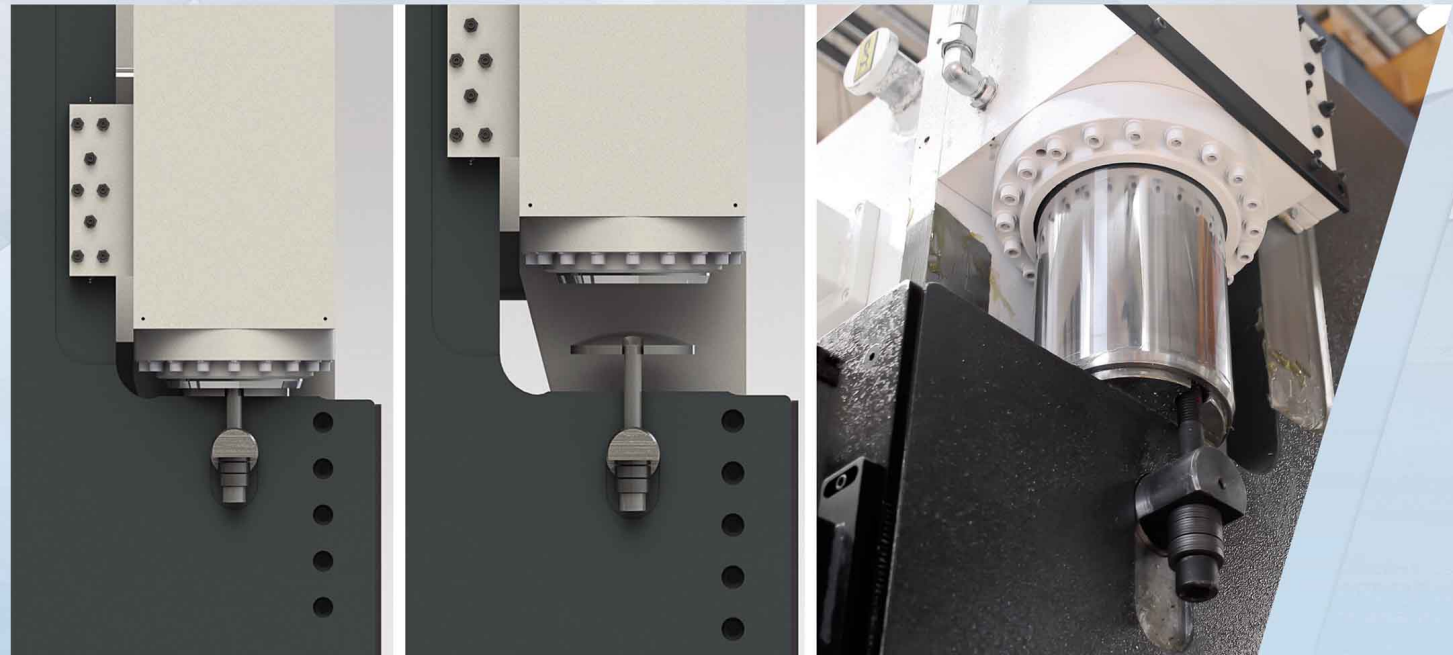

The top plate connections are mounted with double springs as well as spherical connection to the cylinders with double safety.

The parallelism with the top plate can be adjusted more precisely and the proportional valves can work synchronously with each other.



The press brake bodies machined in 5 Axis CNC machines can make more precise bendings and to reduce the friction coefficients to the minimum level.

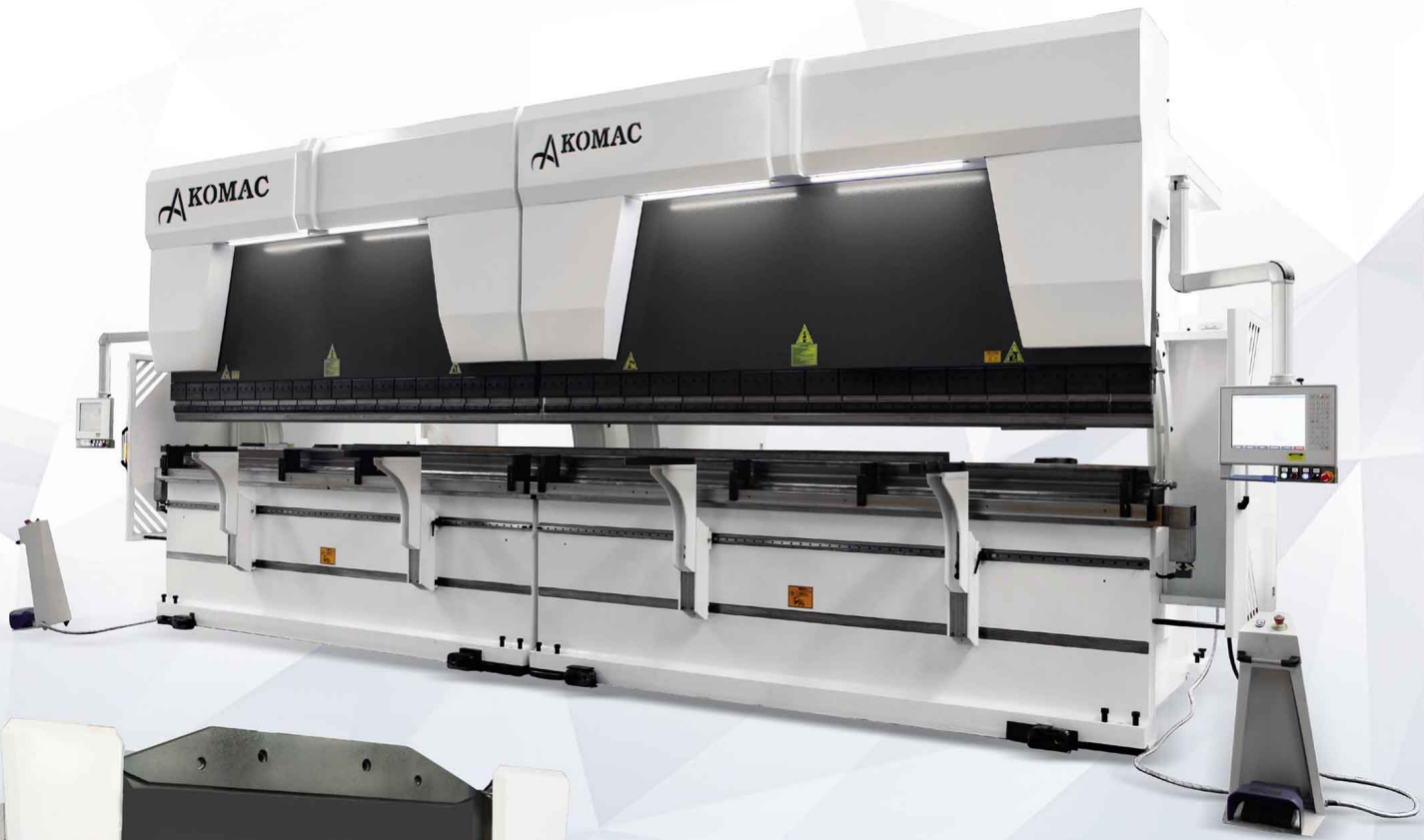

www.akomac.com
info@akomac.com

Address : alı Mah. Yaylacık Yolu Cad. No:3 A/B - Nilüfer -Bursa -TURKEY

A KOMAC

